

Heavy Duty Brass Final Line Pressure Regulator BR-1780 Series

Application

BR-1780 Series Regulators are designed for final line pressure regulation on medical oxygen systems. They are equally suitable for a variety of gases in medical or industrial applications. The BR-1780 Series Regulators have a balanced seat, are constructed with oxygen compatible materials, and offer a tamper resistant adjustment screw cap. Flow performance is impressive as well offering up to 30,000 SCFH for the ¾" and 1" model and up to 20,000 SCFH for the ½" model.

Features

- Maintains a steady downstream pressure across a range of inlet pressures commonly provided by a cryogenic bulk tank.
- Large seat and diaphragm areas provide high capacity with sensitive control of delivery pressure with low falloff.
- Two ¼" FNPT plugged delivery pressure gauge ports are located on each side of the valve.
- Two bonnet drain/vent holes to allow for various mounting orientations.
- Bonnet cap covering adjusting screw for tamper protection.
- Maximum inlet pressure is 500 psig (34 Bar).
- Available in four delivery pressure ranges. (A-D)
- Temperature range: -40° F to +165° F. (-40°C to +74°C)
- Cleaned per CGA G-4.1 for oxygen service.
- 100% Factory Tested



Materials

Body Forged Brass
 Bonnet Forged brass
 Diaphragm Nitrile with PTFE liner
 Springs, fasteners, and adjusting screw Stainless Steel
 Other valve parts Brass
 Seat Disc & O-Rings Viton is standard

For Carbon Dioxide and Nitrous Oxide Service:

Specify EPDM material for seat disc and O-Rings, add "E" to end of part number.

Ordering Information

Part Number	Delivery Pressure Range	Pressure Gauge*		Inlet & Outlet (F.N.P.T.)	Dimensions				
		Range (PSI)	P/N		"A"	"B"	"C"	"D"	C _v
BR-1784A	5-55 psig	1-100	1286	½"	2.82"	3.62"	1.38"	5.21"	3.1
BR-1784B	40-110 psig	1-200	S1679						
BR-1784C	100-200 psig	1-400	15578						
BR-1784D	175-300 psig								
BR-1786A	5-55 psig	1-100	1286	¾"	3.31"	4.69"	1.60"	6.46"	4.8
BR-1786B	40-110 psig	1-200	S1679						
BR-1786C	100-200 psig	1-400	15578						
BR-1786D	175-275 psig								
BR-1788A	5-55 psig	1-100	1286	1"	3.31"	4.69"	1.60"	6.46"	5.5
BR-1788B	40-110 psig	1-200	S1679						
BR-1788C	100-200 psig	1-400	15578						
BR-1788D	175-275 psig								

*Regulator sold without gauge. Order gauge separately.

Heavy Duty Brass Final Line Pressure Regulator BR-1780 Series

Flow Performance

See the Rego Flow Performance Curves section of the catalog for more detailed flow curves.

For Carbon Dioxide or Nitrous Oxide Service, add "E" to end of part number.

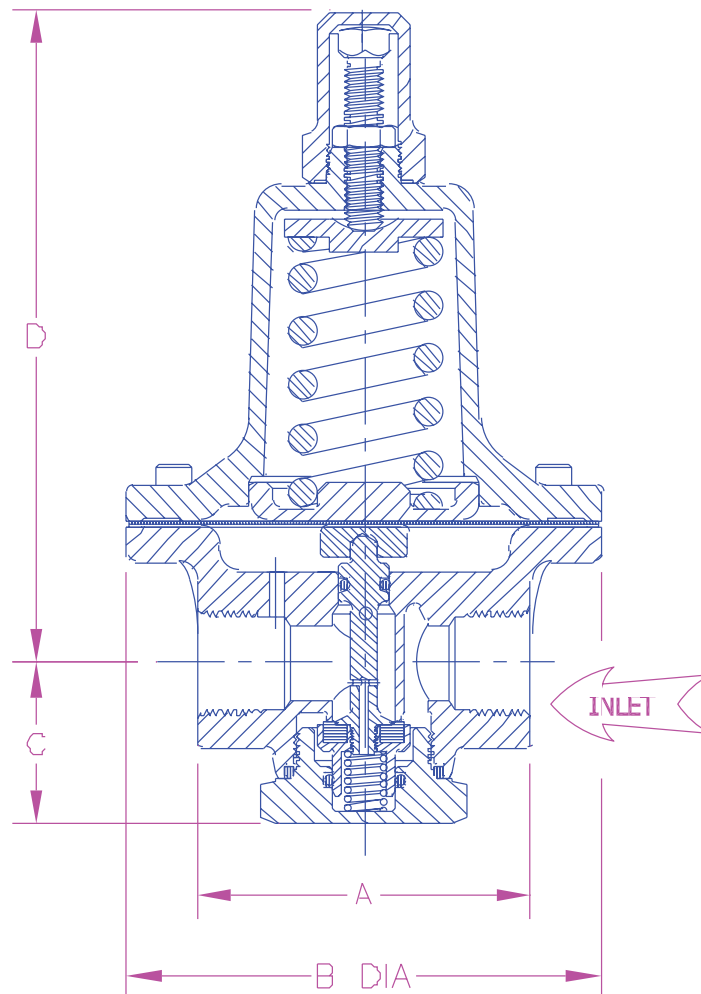

Maintenance and Options Kits

Regulator Models	BR1784	BR1786	BR1788
Repair Kit Part Number	BR-1784-80	BR-1786-80	BR-1786-80

Spring Kit Part Numbers:			
"A" spring 5 –55 psig	BR-1784-7SKA	BR-1786-7SKA	BR-1788-7SKA
"B" spring 40-110 psig	BR-1784-7SKB	BR-1786-7SKB	BR-1788-7SKB
"C" spring 100-200 psig	BR-1784-7SKC	BR-1786-7SKC	BR-1788-7SKC
"D" spring 175-275 psig	BR1784-7SKD	BR-1786-7SKD	BR-1788-7SKD
T-Handle Screw Option Kit	BR-1784ST	BR-1786ST	BR-1786ST

Heavy Duty Line Regulators Performance Curves

1780 Series & BR-1780 Series

"A" spring range 5 - 55 psig

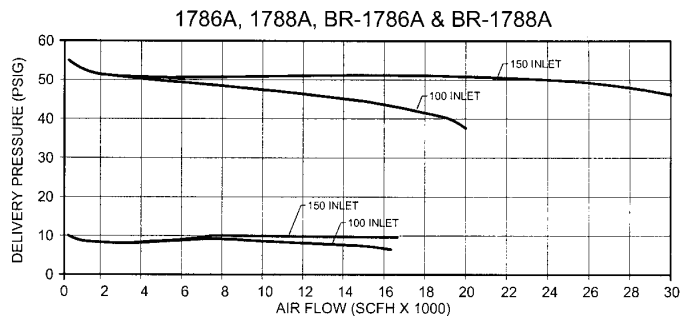
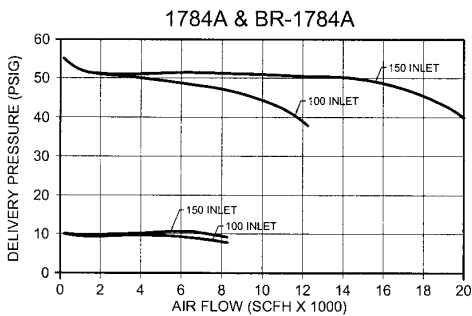

"B" spring range 40 - 110 psig

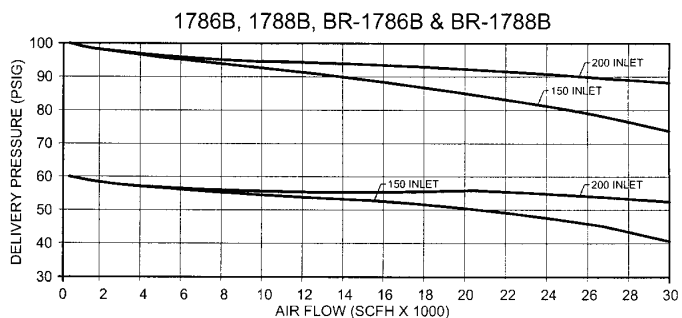
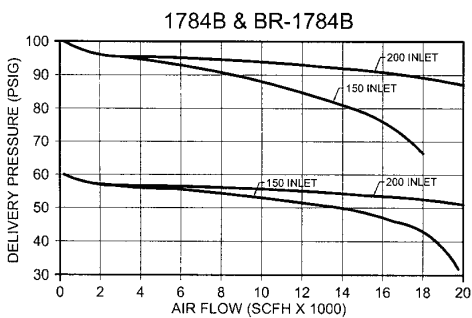

"C" spring range 100 - 200 psig

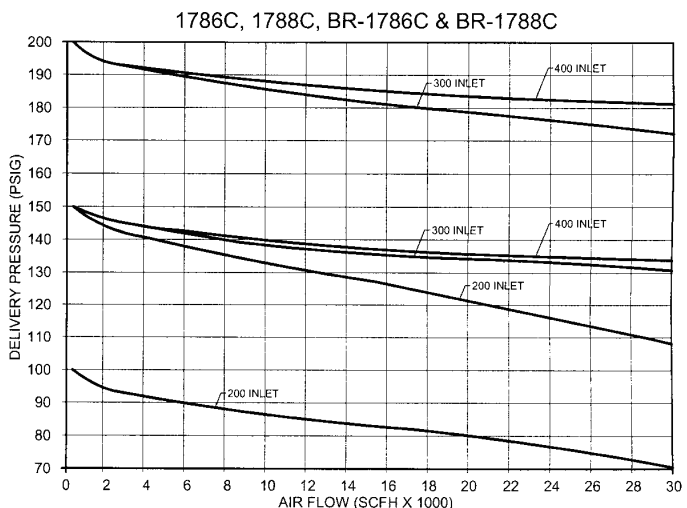
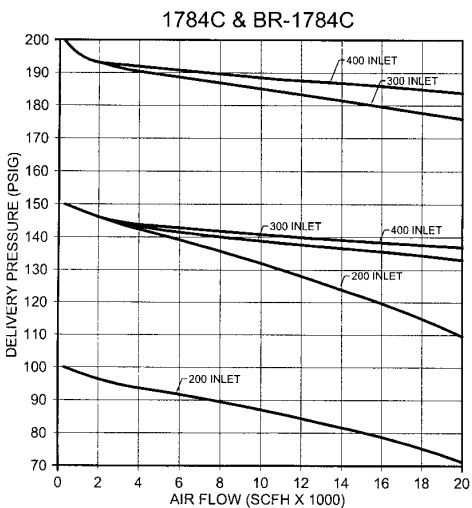

Service		Gas Conversion Table	
Service	Multiply Air Capacity By:	Service	Multiply Air Capacity By:
Acetylene (15 psi max.)	1.06	Fuel Gases	0.86
Argon	0.85	Helium	2.69
Carbon Dioxide	0.81	Hydrogen	3.79
		Nitrogen	1.02
		Natural Gas	1.25

Service	Multiply Air Capacity By:
Nitrous Oxide	0.81
Oxygen	0.95

